

905SWC

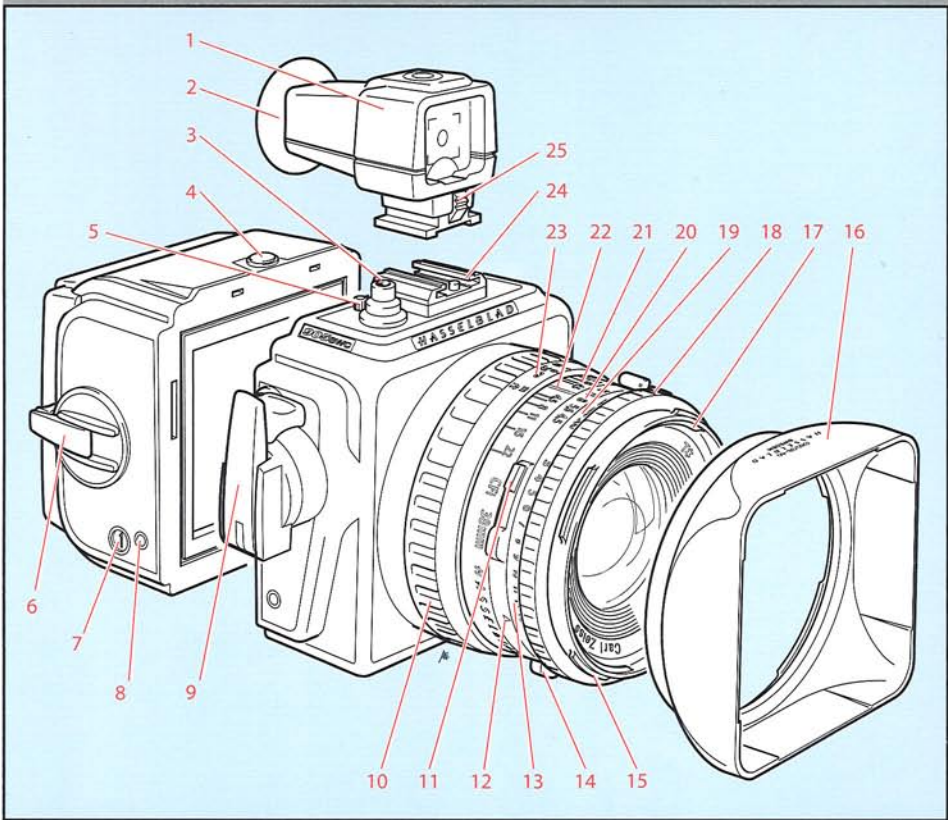

1

905SWC

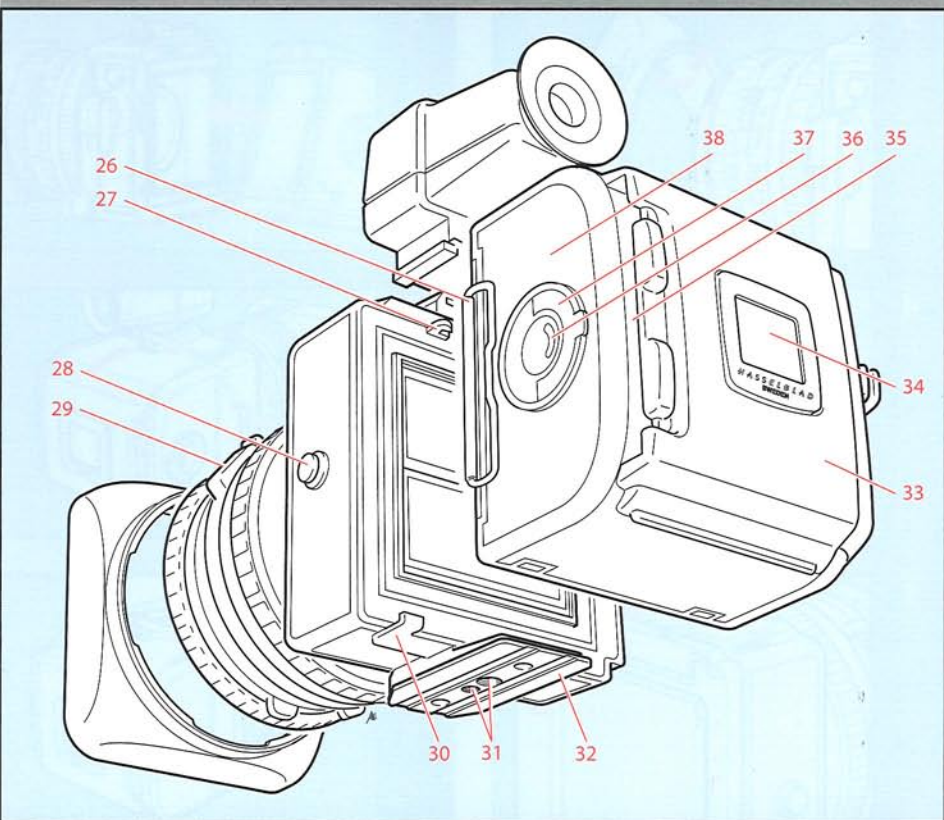

2

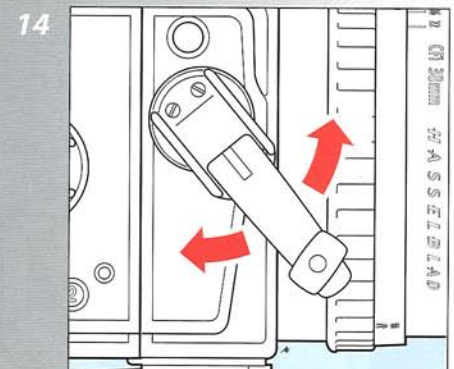
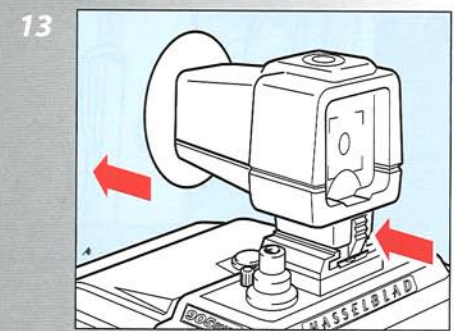
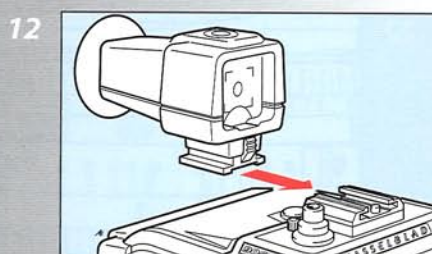
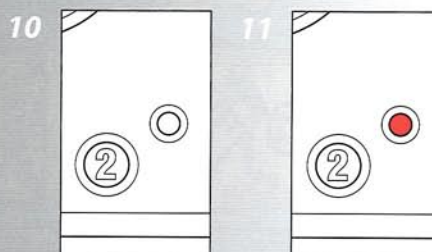
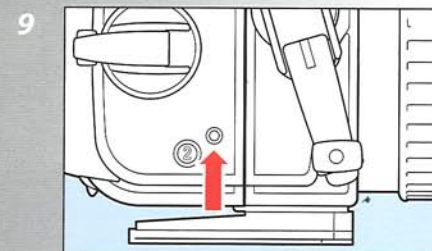
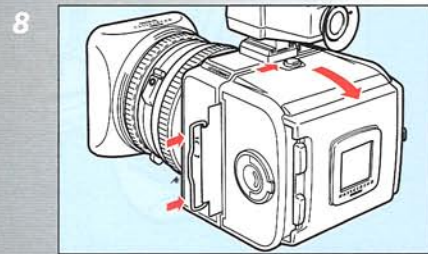
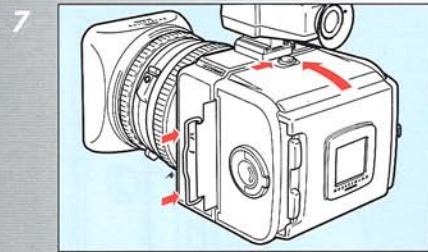
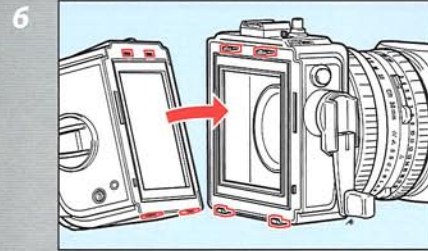
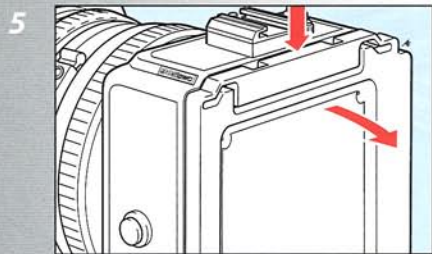
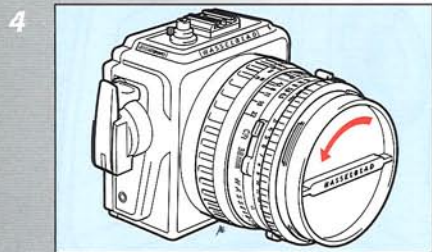
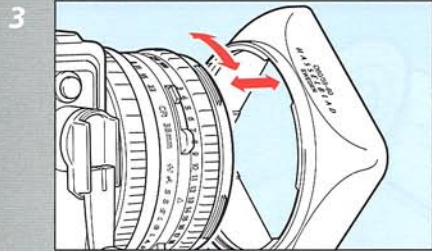

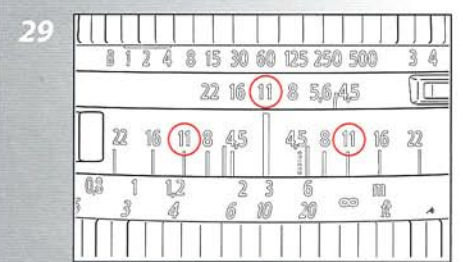
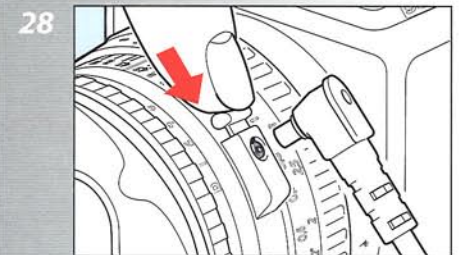
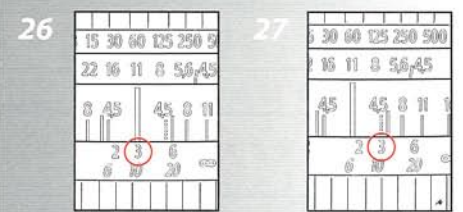
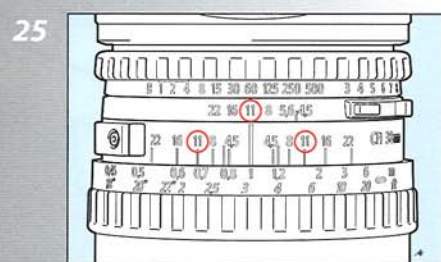
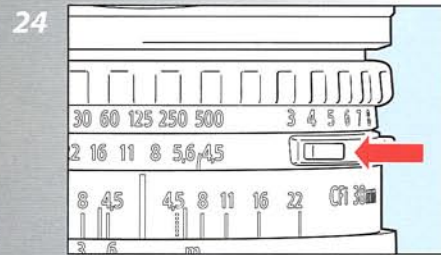
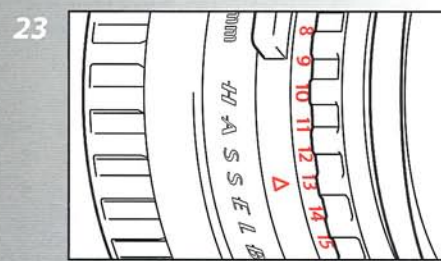
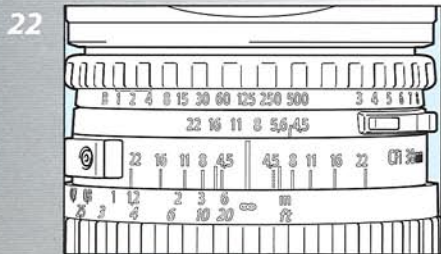
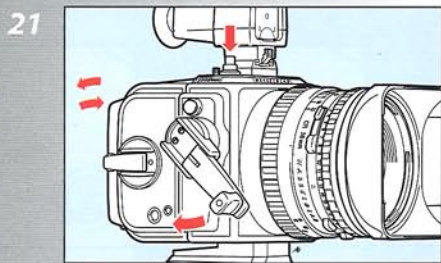
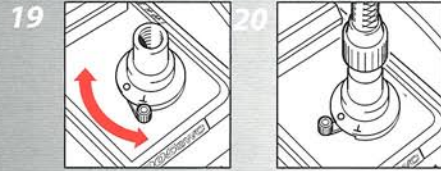
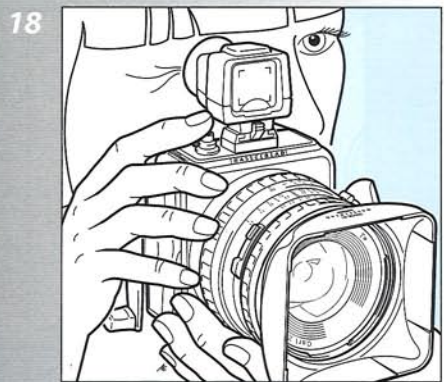
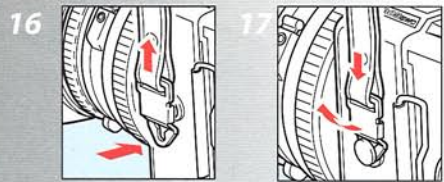
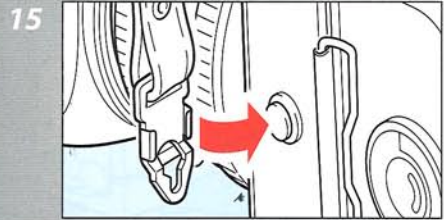

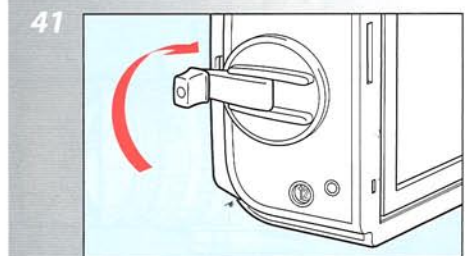
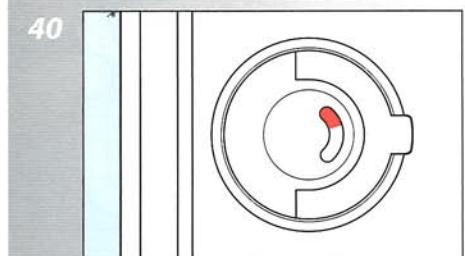
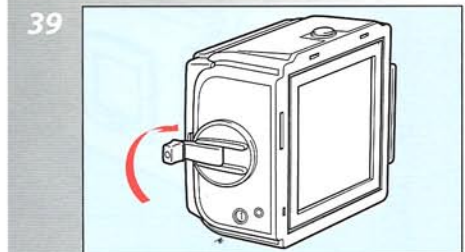
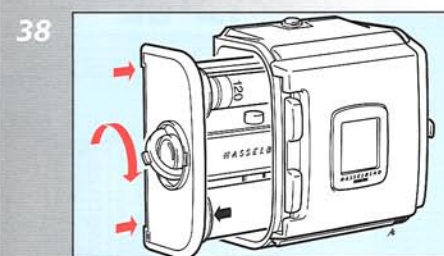
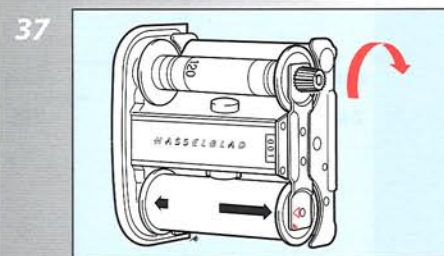
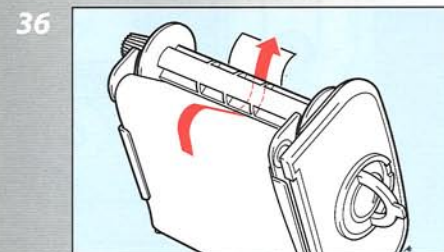
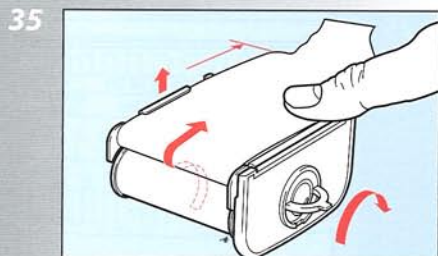
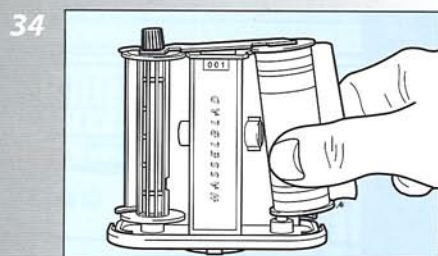
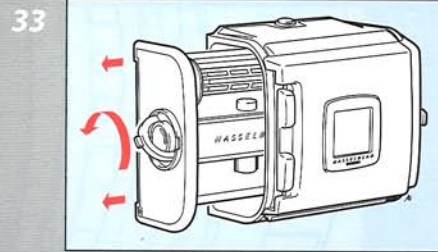
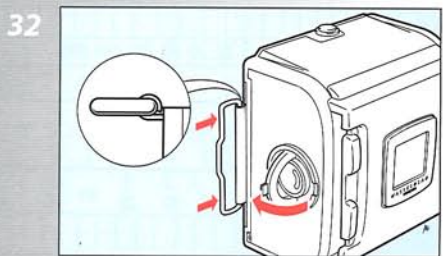
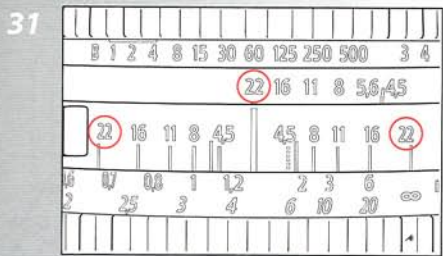
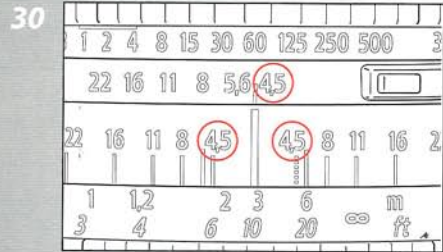

42

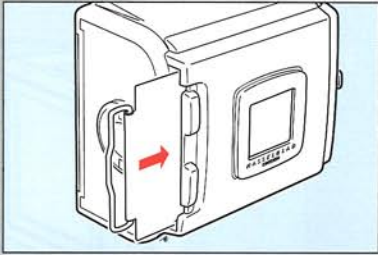

43

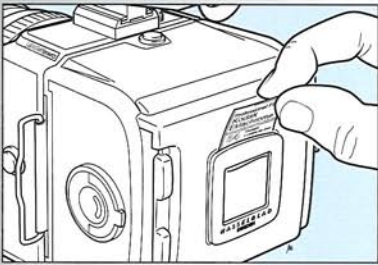

44

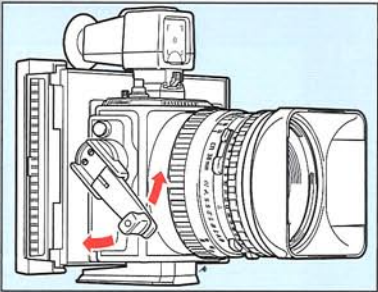

45

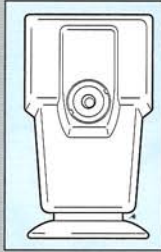

46

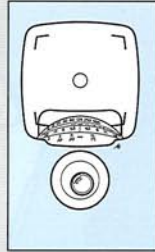

47

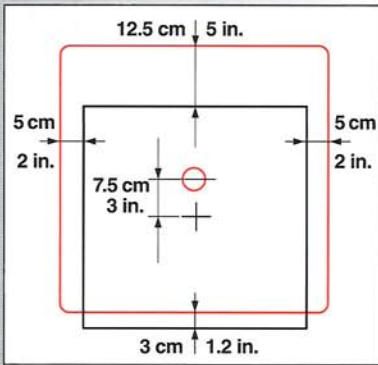

48

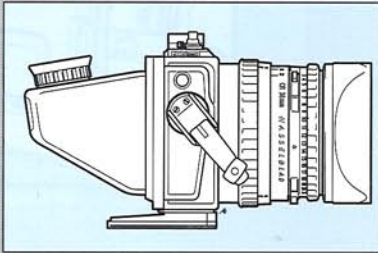

49

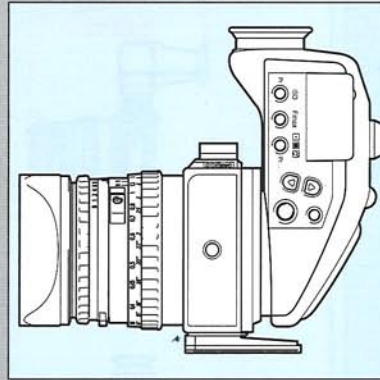

50

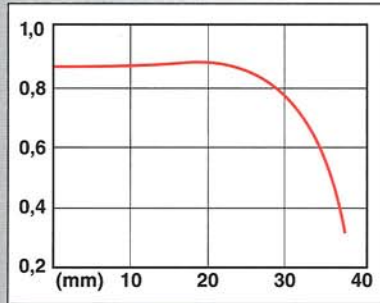

51

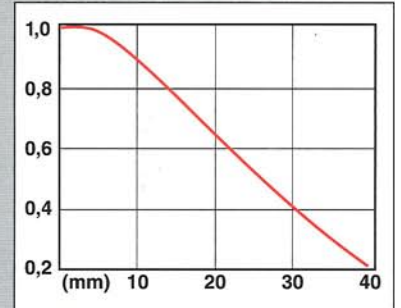

52

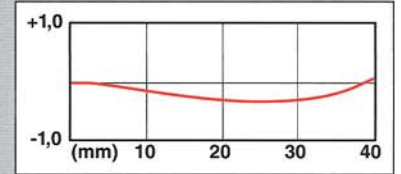

53

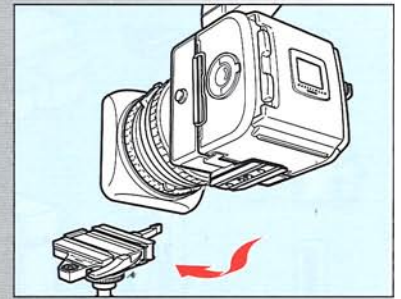

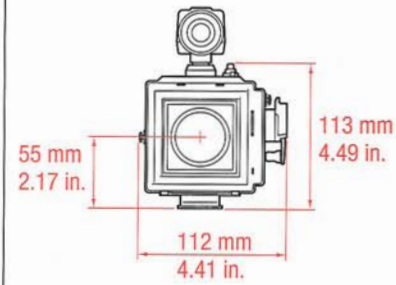
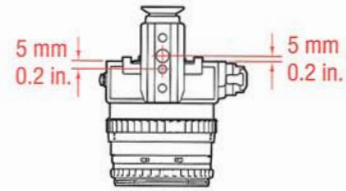
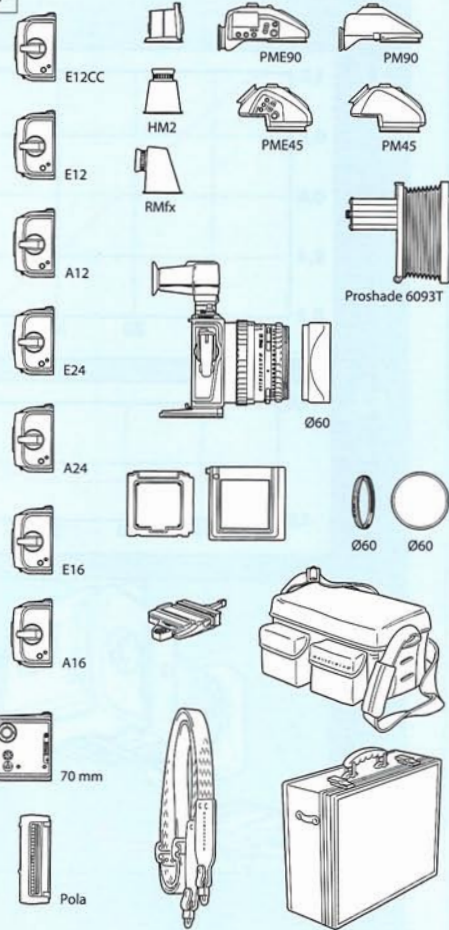

H A S S E L B L A D

905 SWC

Instruction Manual

ENG

Welcome to the Hasselblad Camera System

As a Hasselblad owner, you have in your possession a camera of exceptional quality, the product of an internationally renowned tradition of excellence in the world of photography. It gives you access to the world's largest medium format camera system, the Hasselblad System, which successfully has been taken to the ends of the earth and beyond – into space – to earn its worldwide reputation for quality and reliability.

A range of accessories afford great flexibility and potential for successful photography in almost any application.

Among the different camera models within the Hasselblad System, the 905SWC has a unique position, being the only model that is not a single lens reflex type. The reason is the famous Zeiss Biogon CFi4.5 /38 mm wide-angle lens. The symmetrical design and a very short focal length of this lens leaves no room for a viewfinder mirror between the rear of the lens and the film. Instead of being attached to a single lens reflex camera body the lens is permanently attached to the short and very robust die cast metal housing.

The Hasselblad 905SWC has a detachable optical viewfinder with a built-in spirit level. Through-the-lens viewing is possible by means of the specially designed Focusing screen adapter SWC together with any one of the many Hasselblad viewfinders.

The Hasselblad 905SWC accepts all different types of Hasselblad film magazines for 120, 220 and Polaroid type films with 6x6 cm and 6x4.5 cm image formats.

Like all Hasselblad lenses since the early 1950's with few exceptions, the Biogon CFi4.5/38 lens is manufactured by Carl Zeiss in Germany. The lens can be focused down to 0.3 m (1 ft.) and provides a full image coverage with a 90° diagonal angle field of view, an exceptionally high distortion correction and a highly improved illumination distribution. The lens elements have the highly efficient Carl Zeiss T multi-layer anti-reflection coating on all glass-to-air surfaces.*

See also page 14 for detailed information on the optical properties!

This instruction manual provides a detailed description of how to operate the Hasselblad 905SWC camera. The knowledge gained from carefully studying it will give you access to the Hasselblad potential. Exploiting that potential is left to your skill and imagination!

Congratulations on your choice of a unique camera!

Contents

Introduction

Contents

5. Parts and Components

6. GETTING STARTED

6. Lens shade

6. Lens Protective Cover

7. Rear Cover MultiControl

7. Attaching the Magazine

7. Removing the Magazine

7. The Magazine Status Indicator

7. Attaching the Viewfinder

7. Removing the Viewfinder

8. The Winding Crank

8. Strap Lugs and Strap

8. Removing the Strap

8. Holding the 905SWC

8. OPERATING DETAILS

8. Exposure

8. Time Exposure Lock

8. Cable Release

9. Multiple Exposures

9. LENS AND SHUTTER FUNCTIONS

9. Shutter speeds and Aperture

9. Exposure Values

9. Interlocking of Shutter Speed and Aperture

10. Focusing and Depth-of-field

10. Infrared Photography

10. Flash Synchronization

10. Hyperfocal Setting

11. Loading the Magazine

12. Film Load Indicator

12. Removing the Film

12. Magazine Slide Holder

12. Film Tab holder

12. Film Plane position

12. Magazine for Polaroid Film

12. Viewfinder SWC

12. Spirit Level

13. Image Parallax

13. OTHER VIEWFINDERS

13. Focusing Screen Adapter SWC

13. Using the Focusing Screen Adapter

14. Meter prism viewfinders PME45 and PME90

14. OPTICAL PROPERTIES

14. MTF-function

14. Relative illumination

14. Radial Distortion

15. ACCESSORIES

15. Accessory Mounts

15. Hasselblad Accessory Chart

16. Camera care

16. Troubleshooting

16. Technical Specifications

17. Service and Guarantee

Parts and Components

1. Viewfinder with built-in spirit level **1&2**

2. Rubber eyepiece stray-light protection

3. Shutter release button with threaded cable release socket

4. Magazine catch button

5. Time exposure/TTL viewing lock

6. Film winding crank

7. Frame counter

8. Magazine status indicator

9. Winding crank

10. Focusing ring

11. Exposure value interlock button

12. Exposure value index

13. Exposure value scale (EV)

14. Aperture ring

15. External lens accessory mount

16. Lens shade

17. Internal lens accessory mount

18. Shutter speed ring

19. Shutter speed scale

20. Aperture scale

21. Depth-of-field scale

22. Lens central index

23. Focusing distance scale, inches/feet and metres

24. Viewfinder mount

25. Viewfinder release catch

26. Magazine slide

27. Magazine hooks

28. Strap lug

29. PC flash terminal

30. Magazine supports

31. Tripod sockets, 1/4" and 3/8" threads

32. Quick-coupling plate

33. Magazine slide holder

34. Film tab holder

35. Magazine slide holder slot

36. Film load indicator

37. Film holder key

38. Film holder

*Acute-Matte D designed by MINOLTA

In the text, the positions of components are described in relation to the camera as you see it when taking a photograph, i. e. the lens is on the front, the viewfinder on the top, and the winding crank is on the right hand side.

The relevant illustrations to a particular section are indicated by the figures beside the small headings in the text.

Getting Started

This section describes the steps you must take to make the camera ready to use. You will find comprehensive information on how to operate the camera in the following sections. Paragraph numbers in italic in the headlines and in the text refer to corresponding illustrations in the attached illustrations booklet.

Ensure that the camera is wound before attaching a magazine. The winding crank on the right hand side of the camera is locked against clockwise rotation if the camera is fully wound. Counter-clockwise rotation is possible as the winding crank is on a ratchet. If the crank is not locked, rotate it clockwise until it stops.

Lens shade 3

Remove the lens shade by pushing it against the lens front and rotate counter clockwise to stop. The lens shade is now free from the bayonet and can be removed from the lens front.

Attaching the lens shade is made by reversing the procedure above. Align the index on the lens shade vertically.

Front protective cover 4

Turn the cover (bayonet fitting) in the direction of the arrow (counter-clockwise) and remove.

Rear cover MultiControl 5

Depress the catch, tilt the cover backwards, and lift it off.

Attaching the magazine 6, 7

Ensure that the magazine slide is fully inserted and that the magazine status indicator is white. If the indicator is not white, refer to the instruction on page 7.

Rest the magazine on the camera's magazine supports and ensure that it is properly located. Carefully swing the magazine towards the camera body and check that the camera's magazine hooks fit into the magazine slots. Push the magazine gently but firmly against the hooks while sliding the magazine catch button to the right.

Release the magazine catch button when the magazine makes contact with the rear plate of the camera, and push it to the left to ensure that it has reached the locked position. Remove the magazine slide and insert it in the slide holder on the back of the magazine (see page 8).

Removing the magazine 8

It is advisable to have the camera fully wound and the magazine status indicator showing white. If the magazine status indicator shows a red signal, then wind the camera first.

Insert the magazine slide into the magazine with the hinge towards the front of the camera.

Slide the magazine catch button to the right, tilt the magazine back and lift it off the magazine supports.



Note that the camera cannot be operated when a magazine with the slide inserted is attached to it. The magazine cannot be removed without first inserting the magazine slide.

The magazine status indicator 9, 10, 11

The status indicator on the right hand side of the magazine shows whether the magazine is ready to operate (white) or not (red), i.e. the film has not been advanced after the latest exposure.

Do not attach a magazine showing white to a camera that is not wound! Wind the camera first by a full turn of the winding crank, otherwise you will lose one frame.

Do not attach a magazine showing red to a fully wound camera! It could result in an unintentional double exposure, since the frame in position in the magazine probably already is exposed.

If the status indicator shows red, release the camera (page 8) before attaching the magazine. Then, when you wind the camera, the film will be advanced to the next frame.

Attaching the viewfinder 12

With the catch facing forward slide the viewfinder into the accessory and viewfinder mount until it positively latches onto the stud located at the front end of the mount.

Removing the viewfinder 13

Release the viewfinder by pressing the viewfinder catch in the direction of the arrow while sliding the viewfinder towards the rear of the camera.

The winding crank 14

The permanently attached winding crank has a ratchet to enable the operator to rotate the crank counter-clockwise. This design allows you to position the crank to any desired starting point and operate it either by one full turn or by a pumping action. The latter is necessary when the camera is used with a magazine for Polaroid film.

Strap lugs, attaching the strap 15, 16

Place the main body of the strap clip over one of the camera's strap lugs. Press the tip of the clip towards the camera while pulling back on the strap so that the strap clip slides over the strap lug and locks into position.

Removing the strap 17

Lift the clip locking plate high enough to pass over the strap lug. Slide the clip forward in the direction away from the strap until it is free.

Holding the 905SWC 18

You will find that holding the camera in your left hand as shown in the illustration is the most convenient grip when the camera is hand held. The right hand is then positioned to steady the grip and the index finger on the right hand is used to operate the camera release button.

Operating Details

Exposure

The shutter release button for the 905SWC is situated on the top of the camera.

Ensure that the camera is wound and the magazine slide removed before an exposure is made.

Time exposure lock 19

The time exposure lock lever has two settings:

O = Normal setting used for all shutter speeds except 'B'.

T = The release button locks after being depressed and remains locked until the lever is returned to the 'O' setting.

The 'T' setting can be used for time exposures in conjunction with the shutter speed being set to 'B'.

The winding crank is locked until the lever is returned to the 'O' setting.

 *This locking function 'T' will not operate when a cable release is used. With the 'B' setting on the shutter speed the use of a cable release is recommended (see below).*

Cable release 20

Normally the combined use of a cable release and a camera support is recommended for shutter speeds slower than 1/60 s. The cable release is attached by

screwing it into the threaded socket in the shutter release button.

Multiple exposures 21

The camera is designed to prevent accidental double exposures. However, intentional double and multiple exposures on the same frame can be carried out as follows:

1. Depress the shutter release button and make the initial exposure. The magazine status indicator will change to red.

2. Insert the magazine slide, remove the magazine.

3. Wind the camera by rotating the winding crank one full revolution or by using a pumping action until the crank stops.

4. Replace the magazine and remove the slide.

The unit is now ready to make a second exposure on the same frame. You can make additional exposures in the same manner.

 *In this case an exposure is made with a magazine showing a red status indicator. This represents an exception to the norm.*

Lens and Shutter Functions

Shutter speed and aperture 22

The shutter speed selector ring is the ring located closest to the front of the lens. The desired shutter speed is set opposite the lens index.

The white scale shows the shutter speeds, and the orange scale the exposure values (EV).

The aperture ring is located behind the shutter speed ring. The desired lens aperture is also set opposite the lens index.

Exposure values 23

The combination of aperture and shutter speed set opposite the lens index, determines the exposure. Every combination of shutter speed/aperture has an equivalent exposure value (EV), which you can read or set against the orange EV index on the side of the lens.

Exposure values can also be determined by using an exposure meter having an EV scale.

Interlocking of shutter speed and aperture 24

If you want to change either the shutter speed or aperture without changing the EV (Exposure Value), you can interlock the shutter speed and aperture setting rings. This is carried out by depressing the

interlock button on the right of the aperture scale, then turning the interlocked rings to the desired aperture and speed combination. When interlocked the rings move together, increasing or decreasing the aperture and shutter speed while maintaining the EV for correct exposure.

Focusing and depth-of-field 25

The focusing ring is the wide ring with a knurled rubber grip, set closest to the camera body. The distance scales appear on this ring. The lens is focused by rotating the focusing ring until the measured or estimated distance between the subject and the film plane appears opposite the lens index. The distance is shown in white for metres, and in orange for inches/feet.

Objects closer or further away than the selected distance will appear sharp, within certain limits. The range of sharp focus, i.e. depth-of-field varies with the aperture.

The depth-of-field available at any given aperture setting can be read off the depth-of-field scale on both sides of the central index. The setting in the illustration indicates how to read the depth-of-field scale at an aperture of $f/11$, i.e. approximately from 0.65m (2.3 ft.) to 1.5m (5 ft.).

Infrared photography 26, 27

Infrared (IR) rays (wavelengths longer than 800 nm) form an image on a plane further away from the lens than the image plane for visible light. To compensate for this difference you have to align the chosen

distance against the red IR index instead of the normal lens index. Proceed as follows:

1. **Establish the distance to the subject either by measuring or by focusing on the focusing screen adapter (see page 13).**
2. **Note the measured distance or mark the distance point on the focusing scale opposite the lens index line.**
3. **Adjust the focusing ring until the established distance point is opposite the red IR index.**

Flash synchronization 28

The built-in shutter in the Biogon CFI lens is fully synchronized. A flash connected to the PC terminal fires when the shutter is fully open.

When inserting a flash cord into the socket, keep the lock button pressed in. On release, the cord will be locked into place. To remove, press in the lock button again.

Electronic flash units can be used at all shutter speeds (B and 1 s – 1/500 s).

Hyperfocal setting 29–31

The very short focal length of the 38 mm Biogon CFI lens provides both a 90° angle and a large depth-of-field. This allows successful use of the hyperfocal distance setting method. It is based on the fact that the sharply defined area of a photographic image extends both in front of and beyond the focusing point as described in the section covering 'Focusing and depth-of-field'. The distances limiting the sharply defined area are known as the 'near limit' and the 'far limit'.

To use the hyperfocal distance setting method, first determine the EV-setting and then select the slowest applicable shutter speed. This will give you the smallest possible aperture, and therefore the largest depth-of-field. Rotate the focusing ring so that the infinity mark is set to the far limit, i.e. opposite the selected aperture number to the right of the lens index. Now you can read the near limit distance opposite the aperture number to the left of the lens index. Using this method you will get an image that is sharp from the near limit to infinity.

Example: The measured EV is 13. The selected shutter speed is 1/60 s. This results in an aperture value of $f/11$. By setting the infinity mark at $f/11$ on the far limit, the near limit will land at a distance of 1.2 m (4ft.).

At the widest aperture ($f/4.5$) the near limit is 3 m (10 ft.) and at the smallest aperture ($f/22$) the near limit is as close as 0.65 m (26 in.).

Loading the magazine 32–39

The magazine may be loaded on or off the camera. If it is to be loaded off the camera, then the magazine slide must be inserted, its flat side towards the rear. This allows removal of the film holder for loading.

Follow the procedure below in correct order to load the magazine.

CW = clockwise

C-CW = counter-clockwise

32. **Fold out the film holder key.**

33. **Rotate the key C-CW and withdraw the film holder.**

34. **Place an empty take-up spool under the grooved knob of the spool clamp bar. Insert a roll of film under the other end of the bar, turned the same way as in the illustration. Be sure to remove all the paper band surrounding a new roll of film!**

35. **Turn the film holder key CW to open the film clamp. Pull 8–10 cm (3–4 in.) of paper backing off the film roll and slide the edge under the clamp.**

36. **Insert the tongue of the backing paper into the slot in the take-up spool.**

37. **IMPORTANT!**

Turn the grooved knob CW until the arrow on the paper backing is aligned opposite the triangular film load index on the spool clamp bar, but no further.

38. **Turn the film holder key C-CW and insert the film holder into the magazine. Ensure that it is correctly positioned. Turn the film holder key CW to lock the film holder in the magazine and then fold it back in place.**

39. **Fold out the film winding crank and rotate it CW about ten turns until it stops. Turn the crank C-CW if necessary and fold it in.**



Align the arrow on the paper backing of all ILFORD black & white films against the oblong index (and no further) on the spool clamp bar and not the triangular index as normal.

The figure (1) will now be displayed in the frame counter window, indicating that the magazine is loaded and ready for use.

The magazine's film winding crank is blocked, but only at frame (1). A partially exposed film may be wound off at any frame after that.

The frame counter is automatically reset when the film holder is withdrawn from the magazine.

Film load indicator 40

In the centre of the film holder key there is a crescent-shaped indicator window that shows white when the magazine is freshly loaded. It gradually changes to red as the film is wound through. An all red indicator shows that the film is used up or that the magazine is empty.

Removing the film 41

After the last frame has been exposed and the film advanced, the magazine blocks the camera against further release. To remove the exposed film fold out the film winding crank and rotate it clockwise until you can feel that the film is leaving the supply spool. Withdraw the film holder from the magazine and remove the film.

Magazine slide holder 42

On the rear of the magazine is the slide holder where the magazine slide could be stowed away when not in use.

Turn the slide with the hinge towards the rear to fold the bow fully into the slide holder recesses.

Film Tab Holder 43

The end tab of the film pack can be inserted in the

holder on the back of the magazine as a reminder of the kind of film that has been loaded into the magazine.

Film plane position

The film plane position is represented by the chrome and leatherette contact line behind the magazine slide insertion slit.

Magazine for Polaroid film 44

When a magazine for Polaroid film is used with the 905SWC the film winding crank cannot complete a full revolution. In order to wind the camera, fold out the film winding crank and move it up and down with a pumping motion until it stops.

Viewfinder SWC 45

The optical viewfinder can be attached to the mount on top of the camera body. It shows an image that is slightly larger than the image recorded on the film. There are corner marks that indicate the height of the 6x4.5 cm format and also a centre mark. The lens scales can be seen through a crescent-shaped bifocal optical system in the lower part of the viewfinder image. The optical system allows the wearing of spectacles without problem. The rubber eye-cup, which protects against stray light, may be folded forward if preferred.

Spirit level 46

A transparent spirit level is built into the top of the viewfinder body. The spirit level is displayed be-

neath the viewfinder image area. It has an accuracy of 1° for each mm of bubble travel, i.e. as long as the bubble stays within the centre circle the deviation of the camera position from horizontal does not exceed 1°.

Image parallax 47

The position of the viewfinder – above and slightly behind the lens causes a minor deviation between the area covered by the viewfinder and that covered by the lens. This area covered by the viewfinder is coloured red in figure 47. The centre of the viewfinder area is located about 7.5 cm (3 in.) above the centre of the lens area. The differences in location and size of the viewfinder and lens image areas are illustrated in the figure. At successively longer object distances the parallax becomes small compared with the field of view. For accurate composition and focusing use the focusing screen adapter (see below).

Other viewfinders

All Hasselblad viewfinders can be used on the 905SWC together with the Focusing screen adapter SWC (Cat. No. 41050).

Focusing screen adapter SWC 48

You can use the Focusing screen adapter SWC to check the depth-of-field, the exact area covered and image composition. The adapter attaches to the camera body in the same way as the magazine. The image on the screen can be viewed through any Hasselblad viewfinder and focusing hood.

Using the focusing screen adapter

1. Set the shutter to B.
 2. Set the lens to the maximum aperture (f/4.5).
 3. Set the time exposure lock to 'T' and press the shutter release button.
-  *The cable release cannot be used. The 'T' lock is not operative when the cable release is used.*
4. To check the depth-of-field select the appropriate working aperture.
 5. After checking return the time exposure lock to '0'. This closes the shutter.
 6. Wind the camera to cock the shutter. Replace the focusing screen with a magazine.

Meter prism viewfinders PME45 and PME90

49

Meter prism viewfinders PME45 and PME90 can be used for accurate light metering on the screen of the Focusing screen adapter SWC.

The Meter prism viewfinders PME3, PME5 and PME51 also provide correct metered values. However, older meter prism viewfinders, Focusing screen adapters or their combined use require a reduction of the metered value by 1–2 stops.

Experiment to determine the precise reduction!

Optical Properties

Even at the widest aperture the image produced by the Biogon T* CFI 4.5/38 mm lens is characterized by extraordinary sharpness and brilliance. This together with the very low radial distortion and the remarkably wide focusing range from 0.3 m to ∞ makes it very suitable for architectural, fashion, industrial and technical photography or whenever the highest image quality is required. The graphs (figs 49–51) represent the typical characteristics of MTF (Modulation Transfer Function), Relative Illumination and Radial Distortion. In the graphs the horizontal axis represents the distance from the image centre.

14

MTF-function

50

The graph shows the Modulation Transfer Function, which is a representation of the overall lens quality, for a spatial frequency of 20 line-pairs/mm at an aperture of f/8. A flat curve with a relative value near 1.0 indicates a high quality recording with small losses only.

Relative illumination

51

This graph represents the fall-off of illumination from the image centre, which is given the value 1.0, towards the edges. It includes “natural fall-off” as well as vignetting.

Radial distortion

52

This graph represents the dislocation in % of the distance from the image centre of an image point from its theoretical position. Translated to absolute values the max. distortion of the Biogon CFI lens is far less than 0.1 mm.

Accessories

Accessory mounts

53

The underside of the camera body has 3/8" and 1/4" thread tripod sockets in the centre of the quick coupling plate. The plate and socket accept flash gun brackets and the plate also fits and easily locks into the Hasselblad Tripod quick-couplings.

The lenses accept Ø60 filters and lens shades on the front bayonets.

Hasselblad accessory chart

54

The accessory chart indicates the range of accessories available within the Hasselblad system. Please refer to the Hasselblad product catalogue for complete information on the entire Hasselblad camera system.

15

Troubleshooting

Your camera is built to give long and trouble-free service, especially when you follow the maintenance and care advice at the end of this manual. If however you encounter any operating difficulties because you are not familiar with the Hasselblad camera system, the following table may help to resolve them. If the problem persists and the camera is still under guarantee, you should contact your Hasselblad dealer. If the guarantee has expired, you should contact a Hasselblad authorised Service Center for advice. You can obtain the address of your nearest service centre from your dealer, distributor, our homepage or by contacting us directly.

PROBLEM	POSSIBLE CAUSE	REMEDY
You cannot operate the shutter release button	<ul style="list-style-type: none"> The magazine slide is still in place The roll of film is finished The camera is in the released position 	<ul style="list-style-type: none"> Remove the slide Load a new roll of film Wind the camera
The release button remains depressed	<ul style="list-style-type: none"> The time exposure lock is in the T-position 	<ul style="list-style-type: none"> Return the lock to the Opposition
You cannot remove the magazine	<ul style="list-style-type: none"> The magazine slide is not fully inserted 	<ul style="list-style-type: none"> Insert the magazine slide completely

SERVICE AND MAINTENANCE

While Hasselblad equipment is extremely reliable and durable, cameras and lenses that are in constant intensive use in a professional environment should be maintained and serviced by an authorized Hasselblad Service Center at regular intervals. Further information on service and maintenance can be found on page 18.

GUARANTEE

If your camera was purchased from an authorized Hasselblad outlet, it is covered by an international guarantee for one year. Further details on the guarantee can be found on page 18.

Technical Specifications and Equipment 905SWC

Camera type:	Wide-angle camera for 6x6 cm (2¼ x 2¼") image size with permanently attached lens. Optical viewfinder and interchangeable film magazines.
Design:	Fully mechanical assembly with a one piece cast aluminium alloy camera body. Top camera release button.
Viewfinder:	Detachable optical viewfinder with built-in spirit level and lens scale-viewing system. Magnification 0.23.
Film advance:	Manual advance with simultaneous shutter cocking. Folding winding crank with ratchet coupling.
Lens:	Carl Zeiss Biogon T* CFI 38 mm f/4.5. Focusing range 0.3 m (12") to ∞. Apertures from 4.5 to 22.
Angle of view: Front bayonet:	Diagonal 90°, horizontal 72° with 6 x 6 cm (2¼ x 2¼") format. External and internal for accessories with Ø60. <i>For complete specifications refer to the Product Data Sheet for the Biogon CFI38 mm lens.</i>
Tripod socket:	3/8" and 1/4" socket thread and plate for quick-coupling attachment.
External dimensions:	Camera body only with lens and viewfinder is shown in figure 54. Camera body as above with magazine A12: 147L x 112W x 153H mm (5.71" x 4.41" x 6.00").
Weight:	Camera body only, with lens as above: 940 g (2lb 1.2oz). Camera body, with lens as above and magazine A12: 1365 g (3lb 0.2oz).

Equipment Care, Service and Guarantee

EQUIPMENT CARE

A Hasselblad camera is designed to withstand the rigours of professional use in most environments. To avoid the possibility of damage however, it should be protected from the following:

Extremes of temperature.

High temperatures can have an adverse effect on both the film and the camera. For this reason you should not keep your camera in places where it will get hot, such as in direct sunlight or on a shelf above a radiator. In tropical environments fungus growth can be prevented by ensuring your equipment is kept in an area where the air is circulating. Frequent rapid and severe temperature changes can cause problems such as the corrosion of electrical contacts, and should therefore be avoided. When working in extremely cold temperatures, cameras and especially lenses should be protected as much as possible.

Dust and grit.

You should take care to prevent dirt of any kind from getting into your camera. When taking photographs in coastal areas for example, the camera should be protected from sand and salt water spray.

Dust on the lens glass surface can be removed with a blower brush or a very soft brush if necessary. Smears on the lens glass should be treated with great caution. Light smears could be removed with a high quality lens cleaning solution on a soft, clean tissue. Heavy smears should be treated by a Hasselblad service center. If in doubt do not clean lens glass yourself.

Always be very careful not to scratch the lens or touch any of the glass surfaces with your fingers!

Service.

Faultless camera performance is essential to the professional photographer. It is therefore advisable to check that your camera is functioning correctly before an important assignment. You should also return your camera to a Hasselblad Authorised Service Centre for occasional checking and preventive maintenance. If your camera is used constantly and intensively, exposing for example hundreds of rolls of film per week, check-ups every six months are recommended. Hasselblad Service Centres have the expert staff and specialised equipment necessary to ensure that your camera remains in perfect working order.

Impact.

Your camera can be damaged by severe physical shocks. While you will obviously try not to drop it, you should also take care not to leave it where it can fall or be knocked to the ground, or roll about, such as on the seat of a car.

Troubleshooting.

Your camera is built to give long and trouble-free service. If however you encounter any operating difficulties because you are not familiar with the Hasselblad camera system, the following table may help to resolve them.

Guarantee.

If you purchased your camera from an authorised Hasselblad outlet, it is covered by an international guarantee for one year. The guarantee document and a registration card are supplied with the camera. Keep the guarantee document carefully, but fill in the registration card and return it to your Hasselblad distributor.

10304	905SWC CAMERA BODY CHROME <i>Supplied with the following:</i> Objektiv Biogon CFi4,5/38
52036	Viewfinder
59110	Standard strap
40668	Lens shade 38-60
51643	Front protective cover
51070	Rear protective cover