

OWNER'S MANUAL

This manual will show you how to use and care for your FUJI GX680 Professional correctly. Please follow the instructions carefully.

English (Pages 10 - 23)

See illustrations while you read this manual.

Bedienungsanleitung

Diese Anleitung enthält alles, was Sie über die Bedienung und Pflege Ihrer FUJI GX680 Professional wissen müssen. Lesen Sie die Anleitung bitte aufmerksam durch.

Deutsch (Seite 24 - 38)

Orientieren Sie sich beim Durchlesen dieser Anleitung bitte an den Abbildungen.

MODE D'EMPLOI

Cette brochure est destinée à vous documenter sur l'utilisation et l'entretien de votre FUJI GX680 Professional. Veuillez lire attentivement ces explications.

Français (Pages 39 - 54)

Se reporter aux illustrations en lisant le mode d'emploi.

MANUAL DE INSTRUCCIONES

Este manual le explica cómo utilizar y cuidar correctamente su FUJI GX680 Professional. Sírvase seguir atentamente las instrucciones.

Español (Página 55 - 70)

Consulte las ilustraciones mientras lee este manual.

NAMES OF PARTS/BEZEICHNUNG DER TEILE/NOMENCLATURE/NOMENCLATURA

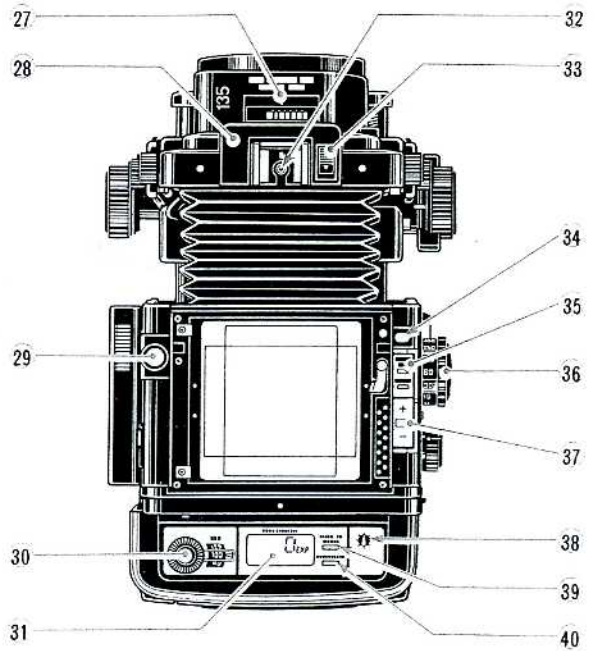
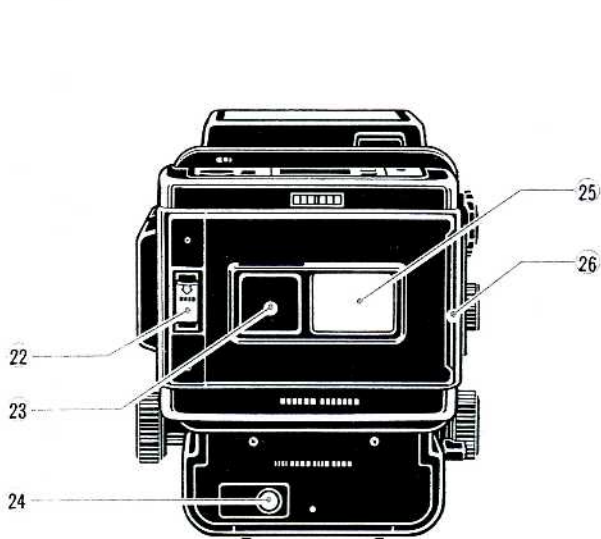
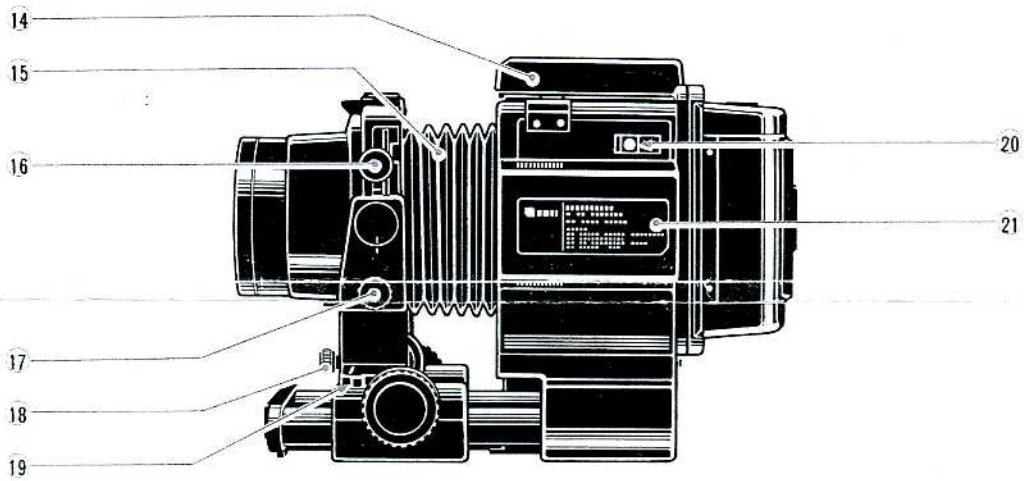
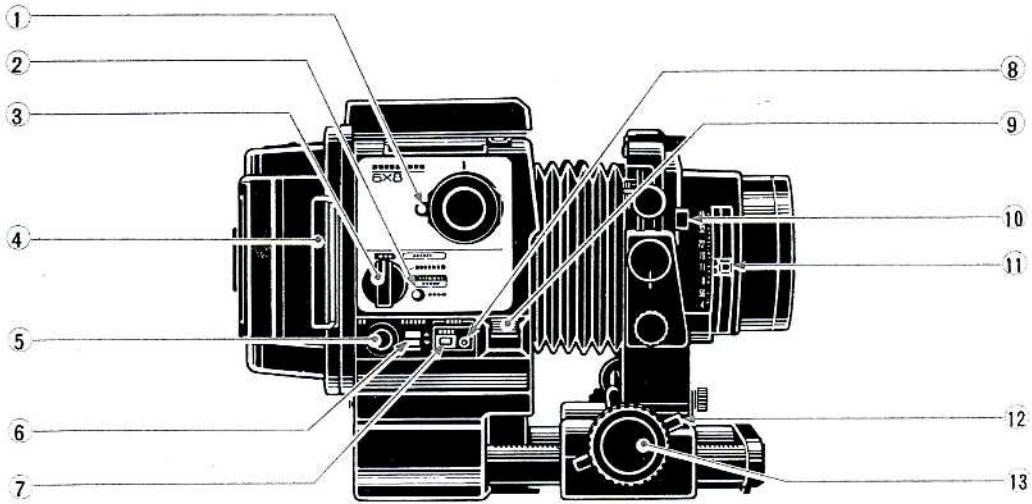

Fig. 1

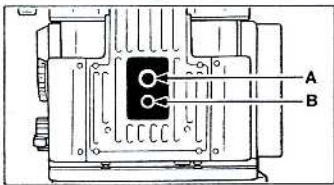

Fig. 2

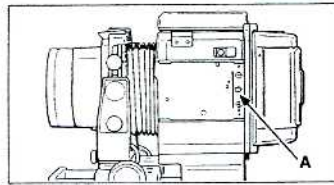

Fig. 3

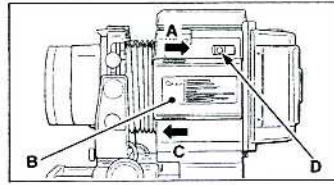

Fig. 4

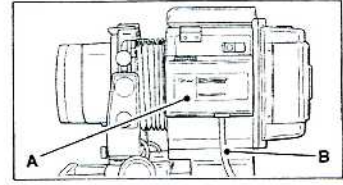

Fig. 9

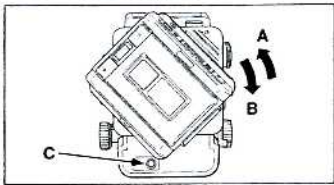

Fig. 10

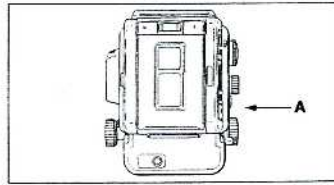

Fig. 11

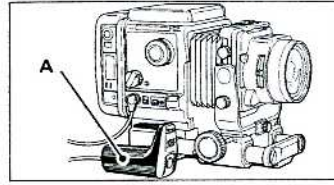

Fig. 12

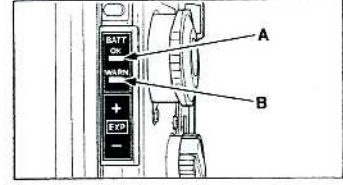

Fig. 17

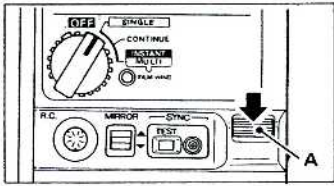

Fig. 18

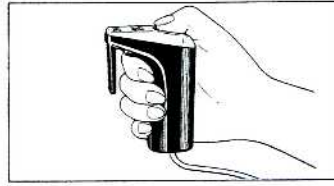

Fig. 19

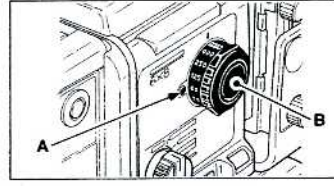

Fig. 20

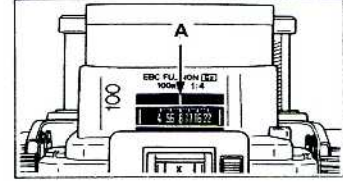

Fig. 25

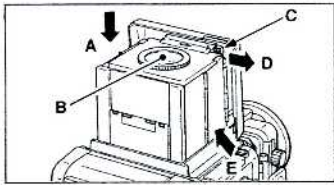

Fig. 26

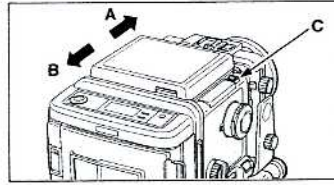

Fig. 27

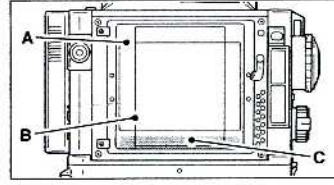

Fig. 28

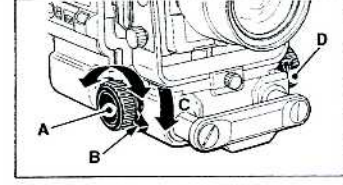

Fig. 33

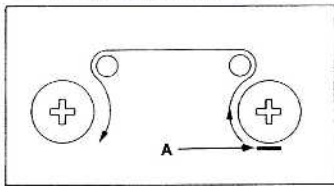

Fig. 34

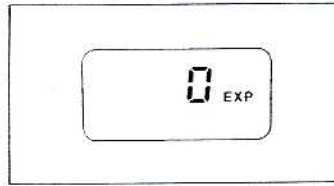

Fig. 35

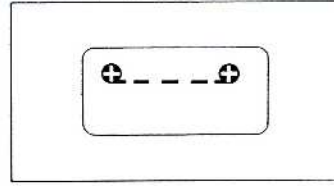

Fig. 36

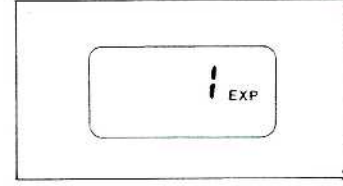

Fig. 41

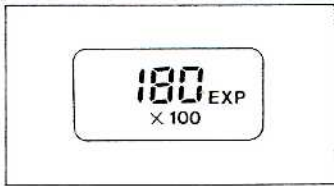

Fig. 42

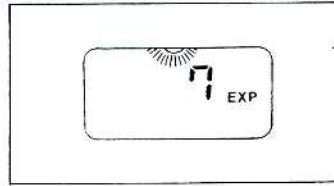

Fig. 43

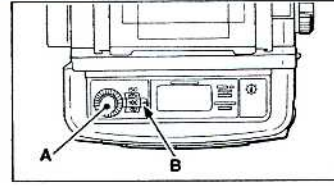

Fig. 44

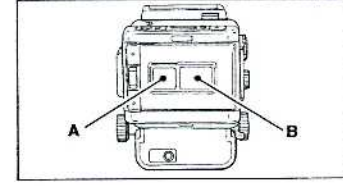

Fig. 49

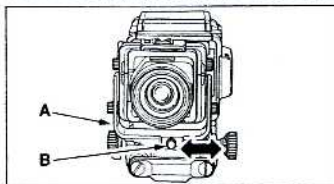

Fig. 50

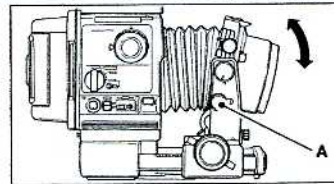

Fig. 51

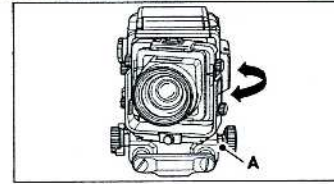

Fig. 52

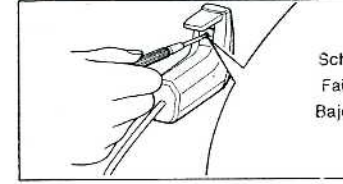

Fig. 56

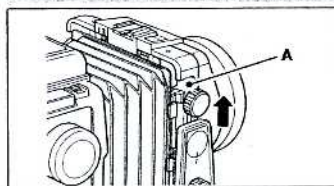

Fig. 57

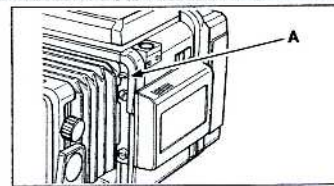

Fig. 58

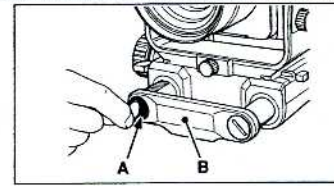

Fig. 59

